

LEES DE INSTALLATIE MANUAL! REFER TO THE INSTALLATION MANUAL!

LENGTH A-C= MAX. 2,5M(120 INCHES) HIGHTA-B= MAX. 1,2M(47 INCHES)

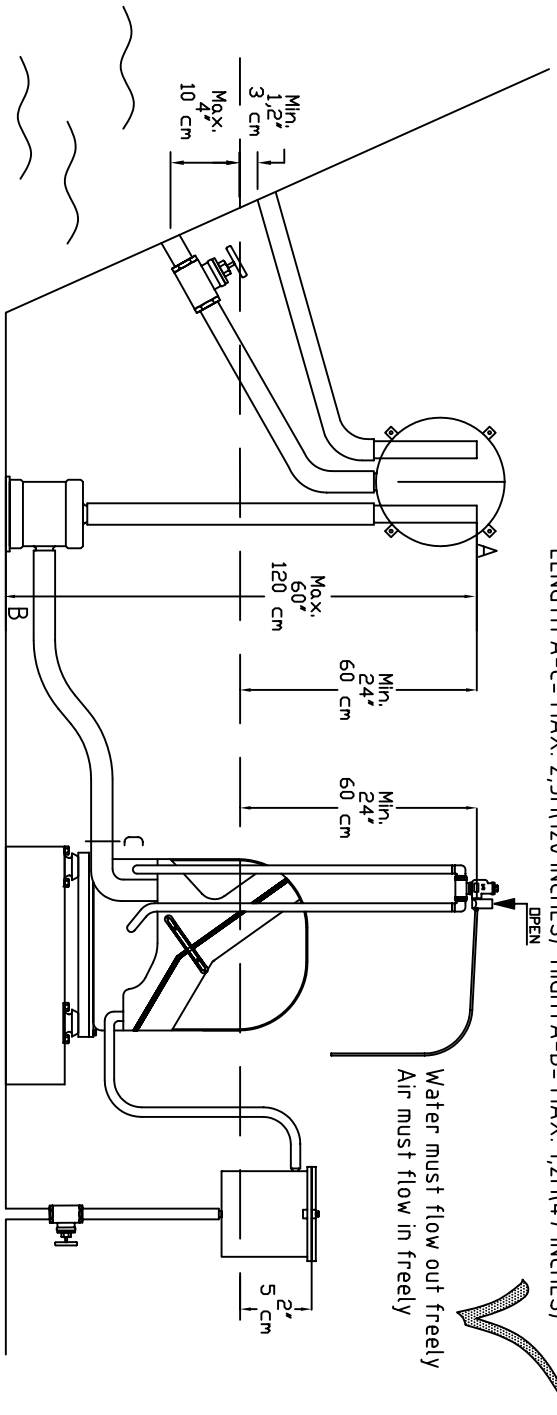

Water must flow out freely
Air must flow in freely

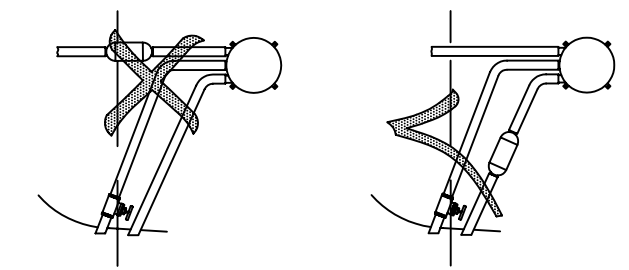
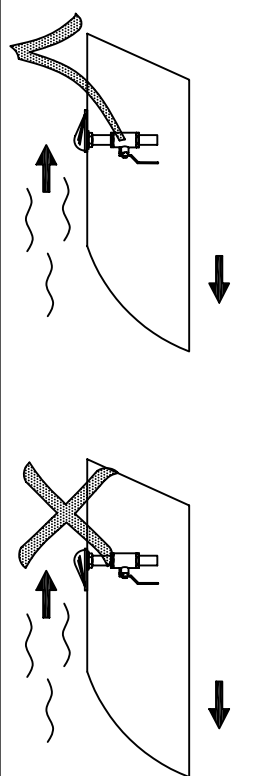
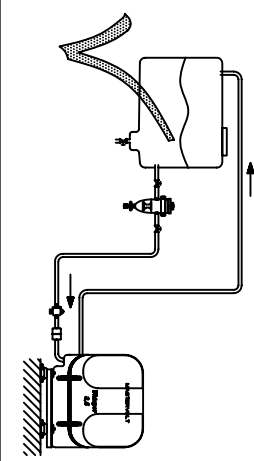
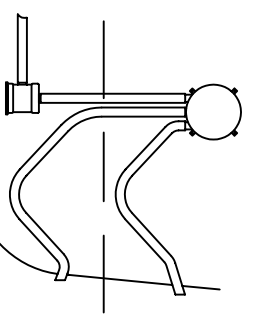
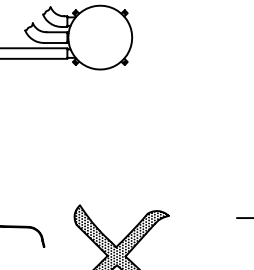
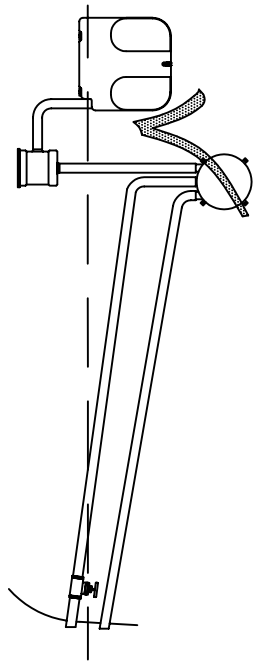
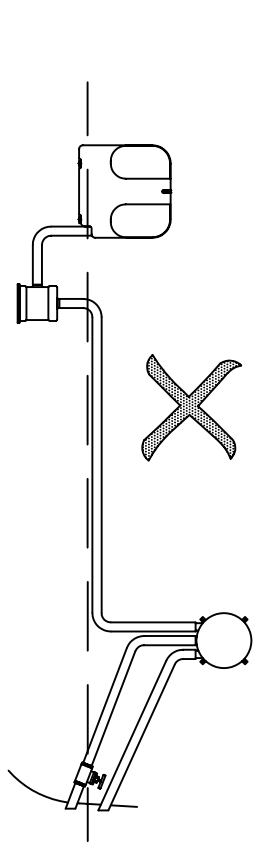
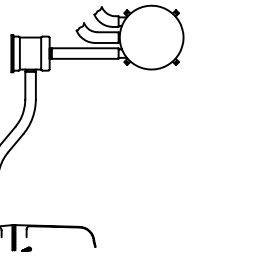
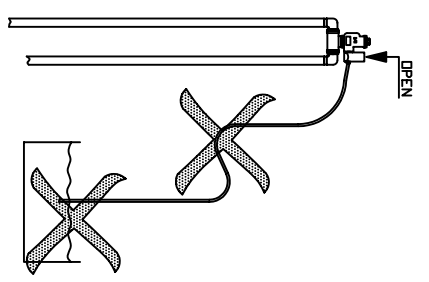

MODEL
Whisper 3,5

EXHAUST
ø4.0 (1 5/8")

WATER INLET
ø13 (1/2")

